

LC-R067R2

For main and standby power supplies
 Expected trickle life: 3~5 years at 25°C, approx. 5 years at 20°C

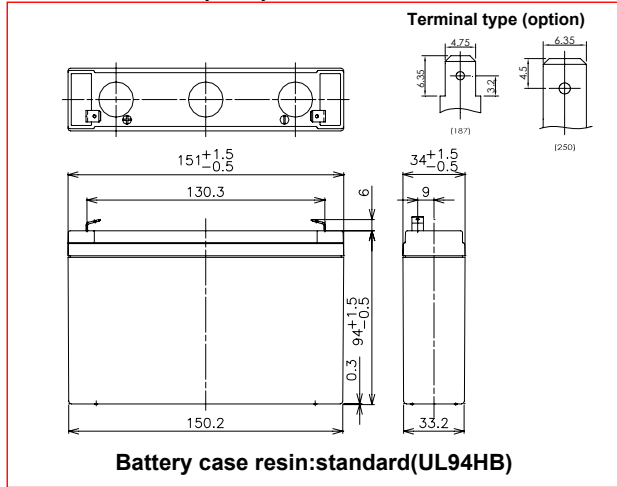

■ Dimensions(mm)



■ Specification

Nominal Voltage	6V	
Nominal Capacity(20HR)	7.2Ah	
Dimensions	Length	151 mm
	Width	34 mm
	Height	94 mm
	Total height	100 mm
Approx. Mass	1.30 kg	
Terminal	Faston 187 & 250	

■ Characteristics

Capacity (25 °C)	20 hour rate	7.2Ah
	10 hour rate	6.8Ah
	5 hour rate	6.3Ah
	1 hour rate	4.9Ah
Internal Resistance	Fully charged battery (25 °C)	11 mΩ
Temperature Dependency of Capacity (20 hour rate)	40 °C	102%
	25 °C	100%
	0 °C	85%
	-15 °C	65%
Self Discharge (25 °C)	After 3 months	91%
	After 6 months	82%
	After 12 months	64%

■ Duration of discharge vs. discharge current

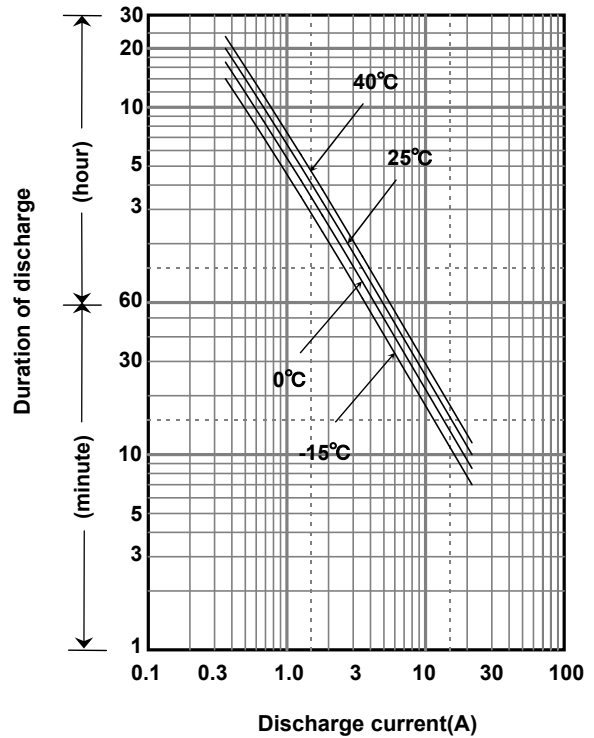

■ Watt Table(25°C)

(Wattage/Battery)

Cut-off V	3min	5min	10min	15min	20min	30min	45min	1h	1.5h	2h	3h	4h	5h	6h	10h	20h	24h
4.8V	216	171	111	85.1	71.3	53.2	37.6	30.0	20.7	16.0	11.9	9.14	7.55	6.07	4.02	2.18	1.82
4.95V	201	160	109	84.5	70.2	52.7	37.3	30.0	20.3	15.9	11.8	9.08	7.49	6.04	4.00	2.17	1.81
5.1V	185	150	106	82.8	69.0	52.1	37.0	29.5	19.8	15.5	11.7	9.02	7.43	6.00	3.96	2.17	1.81
5.25V	165	134	98.6	77.1	65.5	50.9	36.4	28.9	19.4	14.9	11.5	8.96	7.37	5.92	3.94	2.16	1.80
5.4V	139	119	87.9	71.9	63.8	49.1	35.8	28.3	18.9	14.2	11.3	8.84	7.19	5.83	3.90	2.15	1.79

■ Ampere Table(25°C)

(Ampere/Battery)

Cut-off V	3min	5min	10min	15min	20min	30min	45min	1h	1.5h	2h	3h	4h	5h	6h	10h	20h	24h
4.8V	38.9	30.6	19.9	14.8	12.3	9.10	6.40	5.10	3.50	2.70	2.00	1.50	1.26	1.00	0.670	0.360	0.300
4.95V	36.1	28.7	18.5	14.8	12.1	9.00	6.40	5.10	3.40	2.60	2.00	1.50	1.25	1.00	0.670	0.360	0.300
5.1V	33.3	26.9	19.0	14.4	11.9	8.90	6.30	5.00	3.30	2.50	1.95	1.50	1.24	1.00	0.660	0.360	0.300
5.25V	29.6	24.1	17.6	13.4	11.3	8.70	6.20	4.90	3.30	2.50	1.95	1.50	1.23	1.00	0.660	0.360	0.300
5.4V	25.0	21.3	15.7	12.5	11.0	8.40	6.10	4.80	3.20	2.40	1.90	1.50	1.20	1.00	0.650	0.350	0.300

■ Charging Method (25°C)

Cycle use	Control voltage:7.25-7.45V;Initial current:2.88A or smaller
Trickle use	Control voltage:6.8-6.9V;Initial current:1.08A or smaller

■ Cut off voltage

Discharge current	0.36A-1.44A	1.44A-3.6A	3.6A-7.2A	7.2A-14.4A	14.4A-21.6A
Cut off voltage(V)	5.25	5.1	4.95	4.65	4.35

■ Influence of Temperature on Trickle life

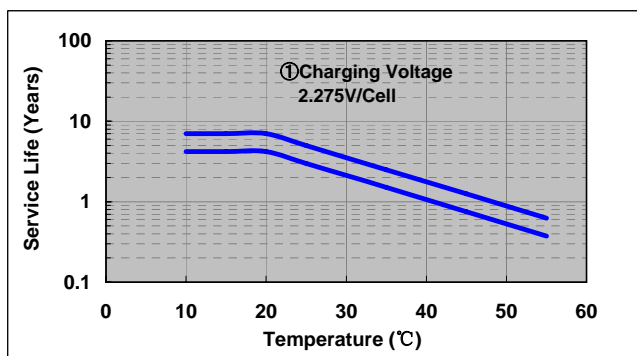

■ Cycle life vs. Depth of discharge

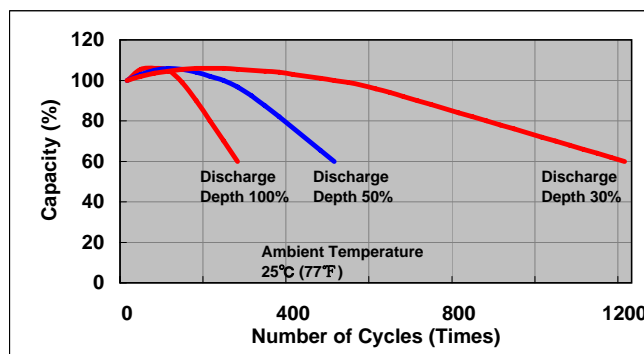

■ Residual capacity test result

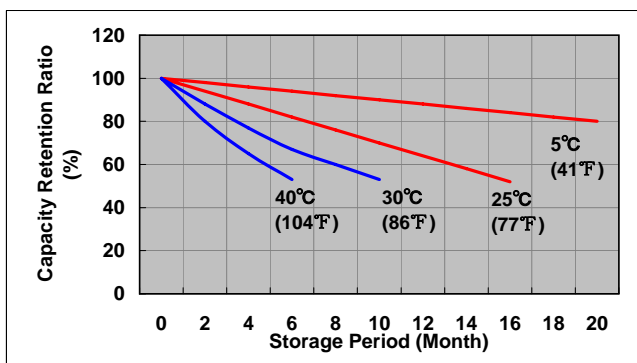

■ Discharge capacity by temperature and by discharge current

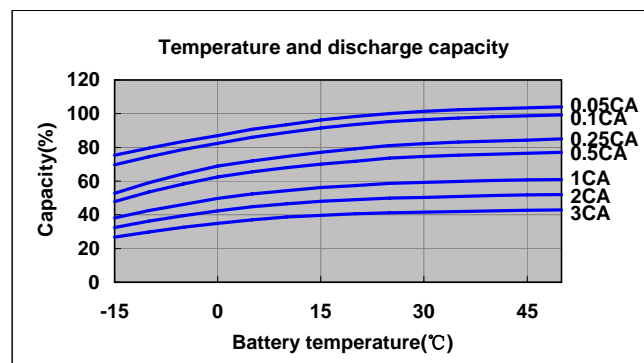

■ Constant-voltage constant-current charge characteristics for Trickle use

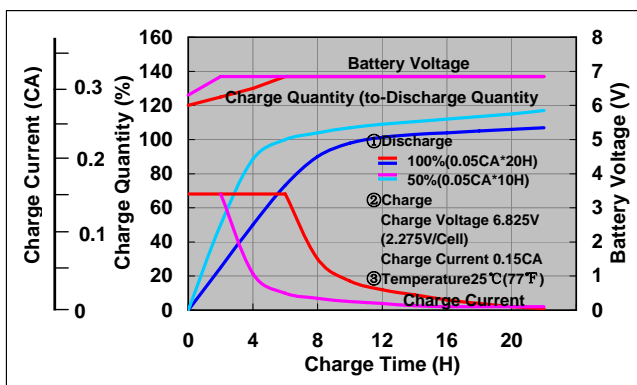

■ Constant-voltage constant-current charge characteristics for Cycle use

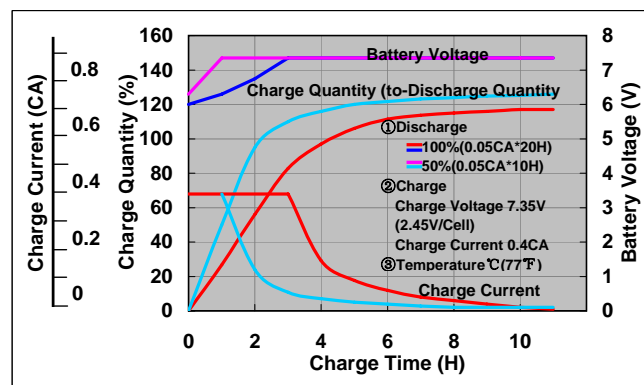

■ Discharge characteristics(25°C)

