

LC-R0615

For main and standby power supplies
 Expected trickle life:3~5 years at 25°C,approx.5 years at 20°C

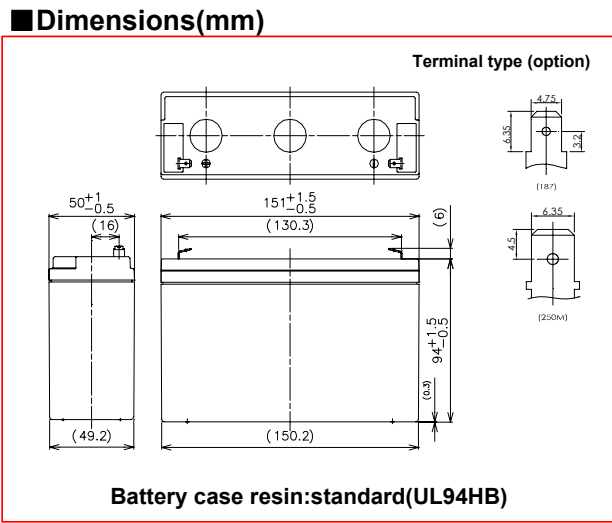
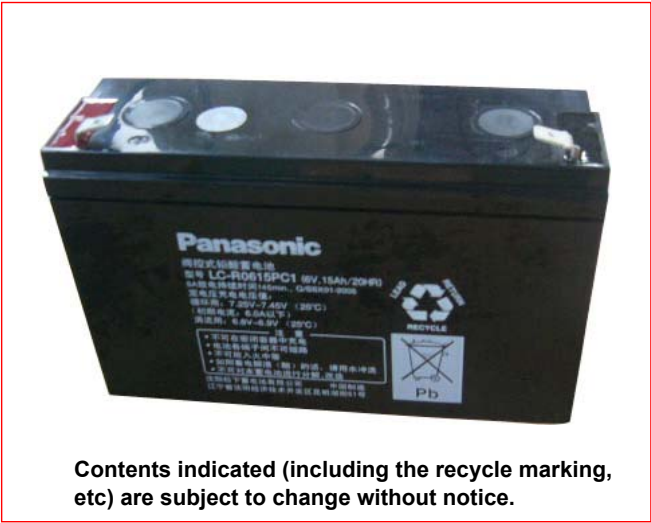

Specification

Nominal Voltage	6V	
Nominal Capacity(20HR)	15Ah	
Dimensions	Length	151 mm
	Width	50 mm
	Height	94 mm
	Total height	100 mm
Approx. Mass	2.05 kg	
Terminal	Faston 187 & 250M	

Characteristics

Capacity (25 °C)	20 hour rate	12Ah
	10 hour rate	11.3Ah
	5 hour rate	10.4Ah
	1 hour rate	8.1Ah
Internal Resistance	Fully charged battery (25 °C)	8 mΩ
	Temperature Dependency of Capacity (20 hour rate)	
	40 °C	102%
	25 °C	100%
	0 °C	85%
	-15 °C	65%
Self Discharge (25 °C)	After 3 months	91%
	After 6 months	82%
	After 12 months	64%

Duration of discharge vs. discharge current

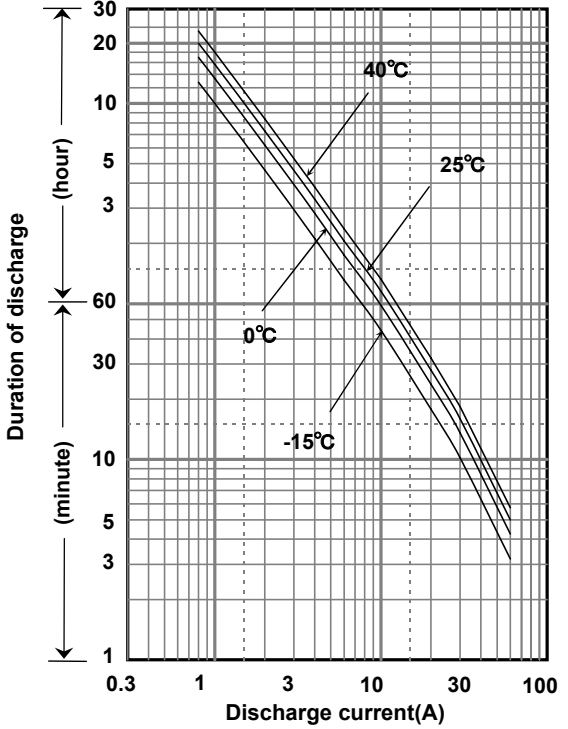

Watt Table(25°C)

Cut-off V	(Wattage/Battery)																
	3min	5min	10min	15min	20min	30min	45min	1h	1.5h	2h	3h	4h	5h	6h	10h	20h	24h
4.8V	425	341	228	175	146	108	78.7	61.7	42.0	32.5	23.6	18.0	14.9	12.6	8.08	4.38	3.65
4.95V	399	323	222	172	143	106	77.8	61.4	41.4	32.3	23.4	17.9	14.9	12.6	8.05	4.37	3.65
5.1V	370	304	216	168	140	106	77.1	60.4	40.7	31.7	23.2	17.9	14.8	12.5	7.97	4.36	3.64
5.25V	333	277	202	159	135	103	76.1	59.1	40.1	30.9	22.8	17.8	14.7	12.4	7.95	4.35	3.62
5.4V	288	249	184	150	132	100	73.1	57.8	38.8	29.8	22.4	17.5	14.4	12.2	7.87	4.33	3.60

Ampere Table(25°C)

Cut-off V	(Ampere/Battery)																
	3min	5min	10min	15min	20min	30min	45min	1h	1.5h	2h	3h	4h	5h	6h	10h	20h	24h
4.8V	76.5	61.2	40.6	30.4	25.2	18.5	13.4	10.5	7.11	5.49	3.96	3.01	2.49	2.10	1.35	0.730	0.609
4.95V	71.8	58.0	39.7	29.9	24.7	18.2	13.3	10.4	7.01	5.45	3.94	3.00	2.48	2.09	1.34	0.728	0.608
5.1V	66.6	54.5	38.6	29.2	24.2	18.1	13.1	10.3	6.89	5.36	3.90	2.99	2.46	2.08	1.33	0.727	0.606
5.25V	59.9	49.8	36.1	27.6	23.3	17.6	13.0	10.0	6.78	5.22	3.84	2.97	2.45	2.07	1.33	0.725	0.604
5.4V	51.8	44.6	32.9	26.1	22.7	17.0	12.5	9.82	6.58	5.03	3.77	2.94	2.41	2.04	1.31	0.722	0.601

■ Charging Method (25°C)

Cycle use	Control voltage:7.25-7.45V;Initial current:6A or smaller
Trickle use	Control voltage:6.8-6.9V;Initial current:2.25A or smaller

■ Cut off voltage

Discharge current	0.75A-3A	3A-7.5A	7.5A-15A	15A-30A	30A-45A
Cut off voltage(V)	5.25	5.1	4.95	4.65	4.35

■ Influence of Temperature on Trickle life

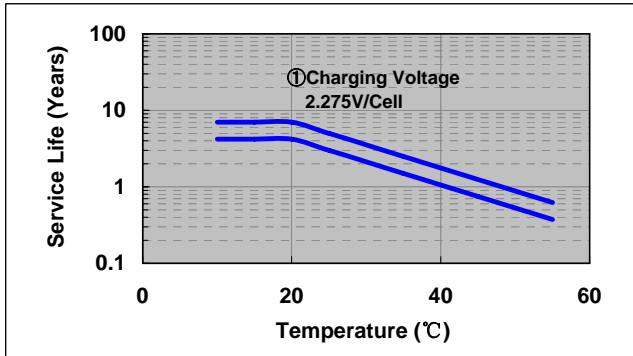

■ Cycle life vs. Depth of discharge

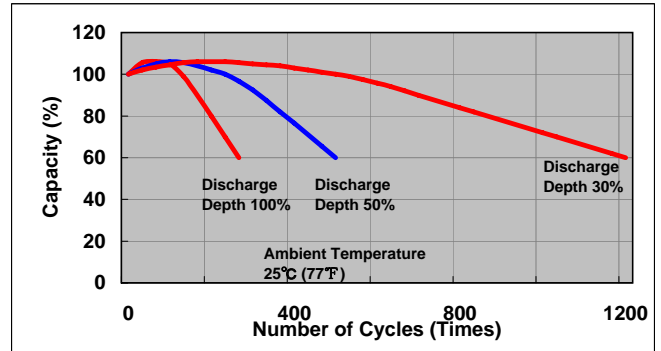

■ Residual capacity test result

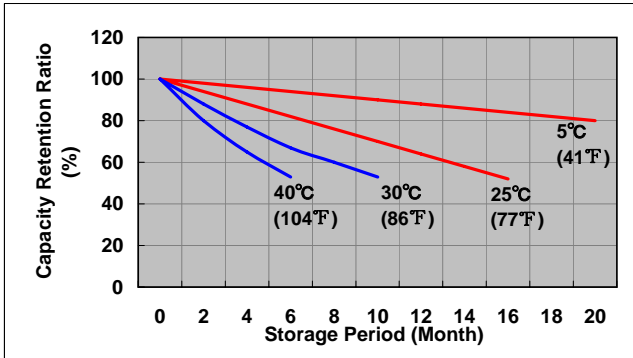

■ Discharge capacity by temperature and by discharge current

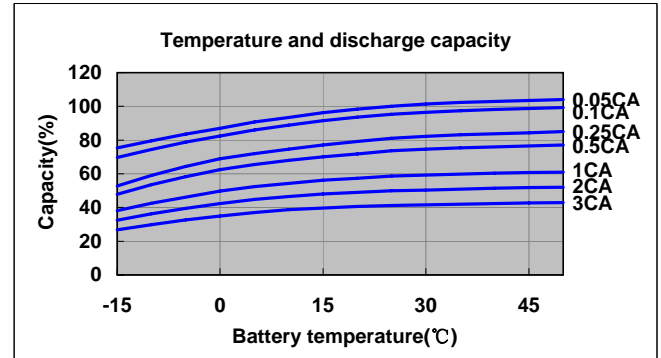

■ Constant-voltage constant-current charge characteristics for Trickle use

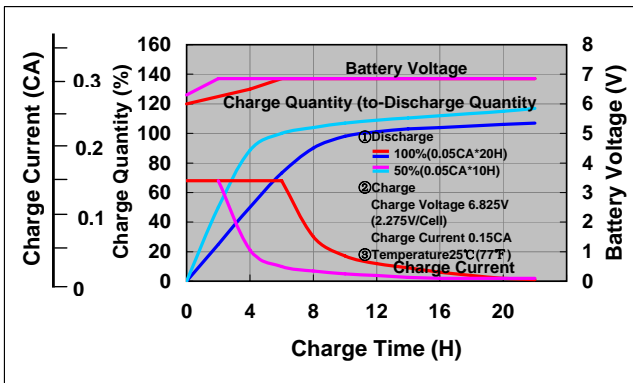

■ Constant-voltage constant-current charge characteristics for Cycle use

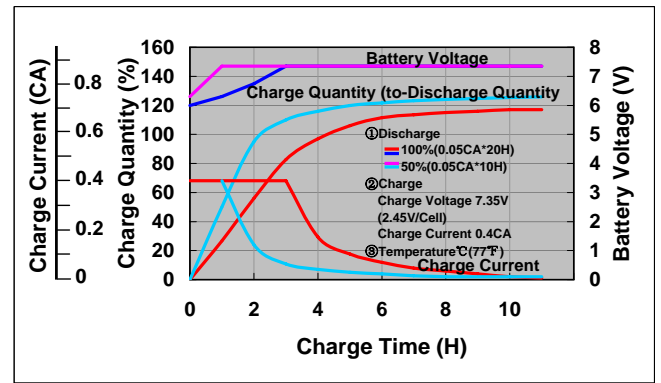

■ Discharge characteristics(25°C)

