



Industriebatterien – Network Power
Powerfit S500
Hohe Energiedichte für maximale Sicherheit.

Technische Informationen

Wenn Wirtschaftlichkeit und Leistungsstärke Ihr Anspruch sind.

Spezifikationen







- Wenn es um unterbrechungsfreie Stromversorgung geht, zeichnen sich die Powerfit S500-Hochstromspeicher durch ihre Wirtschaftlichkeit, ihre Leistungsstärke und ihre Zuverlässigkeit besonders aus
- Sehr gute Hochstromeigenschaften verbunden mit hervorragenden Energiespeichereigenschaften
- Wartungsfrei (kein Wasser nachfüllen) über die gesamte Brauchbarkeitsdauer
- Nennkapazität 25 – 185 Ah
- 7 Jahre Design Life bei einer Umgebungstemperatur von 20 °C (80% Restkapazität)
- Gehäusematerial gemäß UL 94-HB
- Entwickelt unter Berücksichtigung der IEC 60896-21/-22
- Gitterplatten in Blei-Calcium-Legierung
- Extrem gasungsarm durch innere Gas-Rekombinationsrate von 99%
- Niedrige Selbstentladungsrate (ca. 3%/Monat bei 20 °C)
- Keinerlei Transportbeschränkungen betriebsbereiter Blöcke, weder auf der Schiene, auf der Straße, zu Wasser noch in der Luft (nach IATA, DGR Satz A 67)
- Vollständig recycelbar



Applikationen

Powerfit S500-Batterien sind absolut verlässliche Energiespeicher in USV-Anlagen und auf dem Gebiet der Gefahrenmeldeanlagen und Sicherheitsbeleuchtung sowie in allen anderen Bereichen der Sicherheitsstromversorgung.



 Design Life in Jahren: 7	 Nennkapazität 25 - 185 Ah	 Blockbatterie	 Gitterplatte
 Verschlossen	 Recyclebar	 Wartungsfrei (kein Wasser nachfüllen)	

Exide Typ- bezeichnung	Sachnummer	Nenn- spannung V	Nenn- kapazität	Nenn- kapazität	Nenn- kapazität	Länge (l) max. mm	Breite (b/w) max. mm	Höhe (h) max. mm	Gewicht ca. kg	Innen- wider- stand mOhm	An- schluss
			C ₂₀ 1,75 V/Z 20 °C Ah	C ₁₀ 1,75 V/Z 20 °C Ah	C ₁ 1,60 V/Z 20 °C Ah						
S506/130	NAS5060130HW0MC	6	128	121	80,0	272	166	190	23,0	2,40	M-M8
S506/185	NAS5060185HW0MA	6	185	174	116	359	171	226	31,5	1,90	M-M8
S512/25	NAS5120025HW0MA	12	25,0	23,5	15,8	168	127	174	9,50	18,8	M-M6
S512/38	NAS5120038HW0MC	12	38,0	36,0	23,2	198	168	175	13,5	14,7	M-M6
S512/50	NAS5120050HW0MC	12	51,0	48,0	32,5	234	169	190	18,5	10,2	M-M6
S512/60	NAS5120060HW0MC	12	61,0	58,0	40,8	272	166	190	23,0	8,40	M-M6
S512/92	NAS5120092HW0MA	12	92,0	87,0	54,4	359	172	226	30,0	7,60	M-M8

Gehäuse, Anschluss und Drehmoment

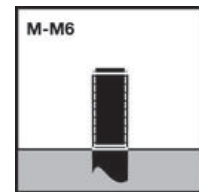

6 Nm

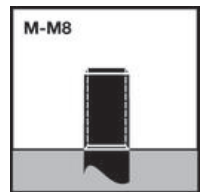

8 Nm

Gehäuse: UL 94-HB = Polypropylen (PP)

S506/130

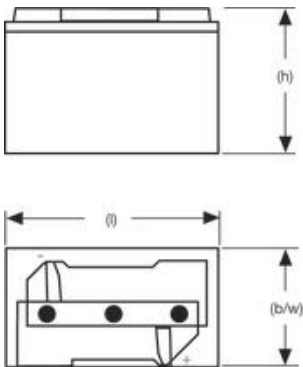

S506/185

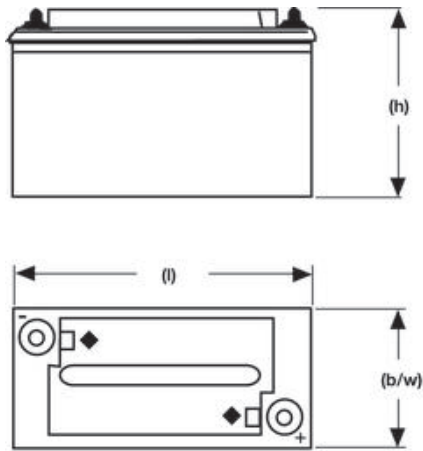

S512/25

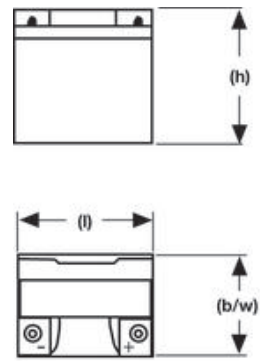

S512/38

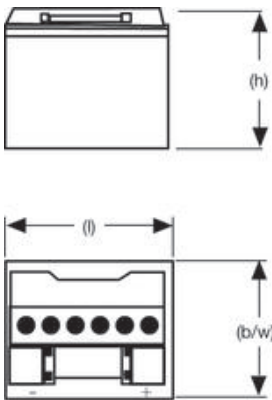

S512/50

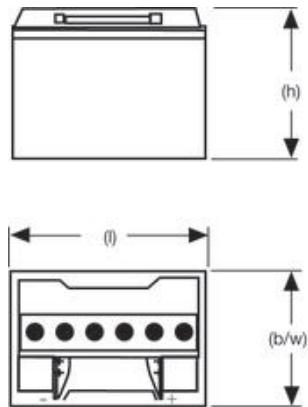

S512/60

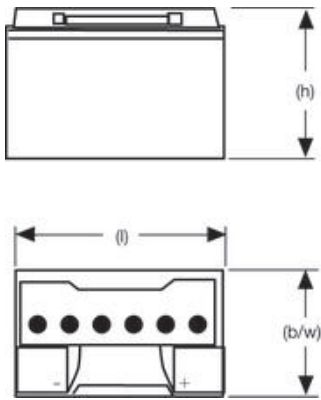

S512/92

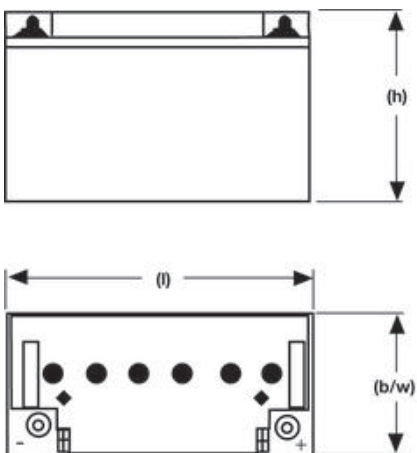

1,95 V/Z – Entladung in A bei 20 °C															
Exide Typ-bezeichnung	Sachnummer	3 min	5 min	10 min	15 min	20 min	30 min	45 min	1 h	2 h	3 h	5 h	8 h	10 h	20 h
S506/130	NAS5060130HW0MC	152	149	133	118	105	86,0	66,0	54,0	30,8	23,5	15,3	10,4	9,10	4,80
S506/185	NAS5060185HW0MA	186	184	180	163	148	123	95,0	78,0	46,0	32,0	21,0	14,3	13,0	6,90
S512/25	NAS5120025HW0MA	35,0	34,0	29,0	25,0	22,0	17,3	13,1	10,7	6,30	4,60	3,10	2,10	1,80	1,00
S512/38	NAS5120038HW0MC	48,0	47,0	41,0	35,0	31,0	25,0	19,0	15,3	9,00	6,50	4,50	3,00	2,60	1,40
S512/50	NAS5120050HW0MC	68,0	66,0	58,0	50,0	43,0	35,0	27,0	22,0	12,5	8,90	6,10	4,20	3,60	1,90
S512/60	NAS5120060HW0MC	102	95,0	79,0	65,0	55,0	43,0	31,5	24,7	14,9	11,0	7,30	4,90	4,20	2,20
S512/92	NAS5120092HW0MA	106	100	87,0	75,0	68,0	56,5	44,0	36,0	22,0	16,2	10,5	7,20	6,40	3,40

1,90 V/Z – Entladung in A bei 20 °C															
Exide Typ-bezeichnung	Sachnummer	3 min	5 min	10 min	15 min	20 min	30 min	45 min	1 h	2 h	3 h	5 h	8 h	10 h	20 h
S506/130	NAS5060130HW0MC	232	220	182	151	130	103	78,5	64,0	37,8	28,0	18,8	12,4	10,8	5,70
S506/185	NAS5060185HW0MA	285	272	241	209	184	146	112	91,0	52,7	37,4	24,5	16,8	15,4	8,20
S512/25	NAS5120025HW0MA	56,0	50,0	39,0	31,0	26,0	20,1	15,4	12,6	7,70	5,80	3,70	2,40	2,10	1,10
S512/38	NAS5120038HW0MC	78,0	70,0	54,0	44,0	37,0	29,0	22,0	18,0	11,3	8,40	5,60	3,70	3,20	1,70
S512/50	NAS5120050HW0MC	111	99,0	77,0	63,0	53,0	41,0	31,5	26,3	15,3	10,7	7,60	5,00	4,30	2,30
S512/60	NAS5120060HW0MC	152	136	103	81,0	67,0	51,0	37,5	29,7	18,5	13,6	9,00	5,90	4,90	2,60
S512/92	NAS5120092HW0MA	156	141	113	94,0	82,0	66,0	50,5	42,0	26,0	19,0	12,5	8,70	7,70	4,10

1,85 V/Z – Entladung in A bei 20 °C															
Exide Typ-bezeichnung	Sachnummer	3 min	5 min	10 min	15 min	20 min	30 min	45 min	1 h	2 h	3 h	5 h	8 h	10 h	20 h
S506/130	NAS5060130HW0MC	312	283	225	181	150	113	86,0	71,0	43,0	31,4	20,8	13,8	11,4	6,00
S506/185	NAS5060185HW0MA	381	354	296	250	214	166	123	100	57,8	41,0	27,8	18,8	16,2	8,60
S512/25	NAS5120025HW0MA	76,0	64,0	47,0	36,5	30,0	22,7	17,1	14,0	8,30	6,30	4,00	2,60	2,20	1,20
S512/38	NAS5120038HW0MC	108	90,0	65,0	52,0	43,0	32,0	24,5	20,0	12,5	9,40	6,10	4,00	3,40	1,80
S512/50	NAS5120050HW0MC	153	129	94,0	73,0	61,0	46,0	35,0	28,5	16,9	12,2	8,30	5,50	4,50	2,40
S512/60	NAS5120060HW0MC	198	168	122	95,0	78,0	57,0	41,5	33,6	20,4	15,1	9,80	6,40	5,30	2,80
S512/92	NAS5120092HW0MA	201	176	136	111	94,0	74,0	56,0	47,0	28,5	21,0	13,8	9,40	8,10	4,30

1,80 V/Z – Entladung in A bei 20 °C															
Exide Typ-bezeichnung	Sachnummer	3 min	5 min	10 min	15 min	20 min	30 min	45 min	1 h	2 h	3 h	5 h	8 h	10 h	20 h
S506/130	NAS5060130HW0MC	382	336	257	199	163	122	91,0	74,0	45,0	33,7	21,8	14,3	11,8	6,20
S506/185	NAS5060185HW0MA	468	417	333	272	231	179	133	106	61,2	44,2	29,2	19,7	17,0	9,00
S512/25	NAS5120025HW0MA	92,0	76,0	52,0	40,0	32,5	24,7	18,2	14,9	9,00	6,80	4,20	2,70	2,30	1,20
S512/38	NAS5120038HW0MC	131	108	75,0	58,0	48,0	36,0	27,0	21,8	13,4	10,2	6,50	4,20	3,50	1,90
S512/50	NAS5120050HW0MC	181	151	107	83,0	68,0	51,0	38,0	30,5	18,4	13,6	8,70	5,70	4,70	2,50
S512/60	NAS5120060HW0MC	231	190	134	104	84,0	61,5	45,0	36,4	21,8	16,0	10,5	6,80	5,60	3,00
S512/92	NAS5120092HW0MA	236	205	155	123	104	80,0	60,0	49,7	29,5	21,9	14,5	9,90	8,50	4,50

1,75 V/Z – Entladung in A bei 20 °C															
Exide Typ-bezeichnung	Sachnummer	3 min	5 min	10 min	15 min	20 min	30 min	45 min	1 h	2 h	3 h	5 h	8 h	10 h	20 h
S506/130	NAS5060130HW0MC	440	384	276	215	174	128	94,0	77,0	46,4	34,8	22,3	14,6	12,1	6,40
S506/185	NAS5060185HW0MA	529	467	362	291	245	187	139	110	63,3	45,5	30,0	20,2	17,4	9,30
S512/25	NAS5120025HW0MA	104	83,0	56,0	43,0	34,5	25,7	18,8	15,1	9,20	6,90	4,30	2,80	2,40	1,30
S512/38	NAS5120038HW0MC	147	118	82,0	62,0	50,0	37,0	27,5	22,3	13,6	10,4	6,60	4,30	3,60	1,90
S512/50	NAS5120050HW0MC	206	168	116	88,0	71,0	53,0	39,0	31,0	18,9	13,9	8,90	5,80	4,80	2,60
S512/60	NAS5120060HW0MC	256	208	145	109	89,0	64,5	47,0	38,3	22,4	16,5	10,7	7,00	5,80	3,10
S512/92	NAS5120092HW0MA	269	226	164	130	108	82,0	62,0	51,0	30,5	22,6	14,9	10,2	8,70	4,60

1,70 V/Z – Entladung in A bei 20 °C

Exide Typ-bezeichnung	Sachnummer	3 min	5 min	10 min	15 min	20 min	30 min	45 min	1 h	2 h	3 h	5 h	8 h	10 h	20 h
S506/130	NAS5060130HW0MC	479	412	293	223	179	133	97,0	78,0	47,2	35,6	22,7	14,8	12,3	6,60
S506/185	NAS5060185HW0MA	583	512	389	308	253	192	142	112	64,6	46,3	30,7	20,6	17,8	9,40
S512/25	NAS5120025HW0MA	112	89,0	60,0	45,0	36,5	26,5	19,2	15,3	9,30	7,00	4,40	2,90	2,40	1,30
S512/38	NAS5120038HW0MC	160	128	86,0	65,0	52,0	38,0	28,0	22,7	13,8	10,5	6,70	4,40	3,70	2,00
S512/50	NAS5120050HW0MC	223	181	121	92,0	74,0	54,5	40,0	31,5	19,1	14,1	9,00	5,90	4,90	2,60
S512/60	NAS5120060HW0MC	276	223	152	114	92,0	66,5	49,0	39,2	23,0	17,0	10,8	7,10	5,90	3,20
S512/92	NAS5120092HW0MA	309	253	175	136	112	84,0	63,5	52,3	31,3	23,2	15,3	10,3	8,80	4,70

1,65 V/Z – Entladung in A bei 20 °C

Exide Typ-bezeichnung	Sachnummer	3 min	5 min	10 min	15 min	20 min	30 min	45 min	1 h	2 h	3 h	5 h	8 h	10 h	20 h
S506/130	NAS5060130HW0MC	506	432	303	230	186	136	99,0	79,0	47,8	36,2	22,9	14,9	12,9	6,70
S506/185	NAS5060185HW0MA	643	555	404	316	260	196	144	114	65,8	47,3	30,9	20,8	17,9	9,50
S512/25	NAS5120025HW0MA	119	94,0	62,0	46,0	37,5	27,2	19,6	15,5	9,40	7,00	4,40	2,90	2,40	1,30
S512/38	NAS5120038HW0MC	169	134	88,0	66,0	53,0	39,0	28,5	23,0	14,0	10,6	6,80	4,40	3,70	2,00
S512/50	NAS5120050HW0MC	238	190	126	95,0	76,0	55,5	40,5	32,0	19,3	14,3	9,10	5,90	4,90	2,60
S512/60	NAS5120060HW0MC	297	237	158	119	95,0	68,5	50,0	39,8	23,3	17,3	10,9	7,10	5,90	3,20
S512/92	NAS5120092HW0MA	347	279	185	141	115	86,0	65,0	53,6	32,0	23,6	15,4	10,4	8,80	4,70

1,60 V/Z – Entladung in A bei 20 °C

Exide Typ-bezeichnung	Sachnummer	3 min	5 min	10 min	15 min	20 min	30 min	45 min	1 h	2 h	3 h	5 h	8 h	10 h	20 h
S506/130	NAS5060130HW0MC	519	441	312	237	190	138	100	80,0	48,4	26,6	23,1	15,0	12,5	6,70
S506/185	NAS5060185HW0MA	678	581	419	328	267	199	146	116	66,3	47,6	31,0	20,9	17,9	9,50
S512/25	NAS5120025HW0MA	123	97,0	64,0	47,0	38,5	27,9	19,9	15,8	9,50	7,00	4,40	2,90	2,40	1,30
S512/38	NAS5120038HW0MC	174	138	90,0	67,0	54,0	40,0	29,0	23,2	14,1	10,7	6,80	4,40	3,70	2,00
S512/50	NAS5120050HW0MC	248	197	130	97,0	77,0	56,5	41,0	32,5	19,5	14,4	9,10	5,90	4,90	2,60
S512/60	NAS5120060HW0MC	311	247	162	122	97,0	70,5	51,0	40,8	23,5	17,4	10,9	7,10	5,90	3,20
S512/92	NAS5120092HW0MA	370	292	192	145	117	87,5	66,0	54,4	32,3	23,8	15,4	10,4	8,80	4,70

1,90 V/Z – Entladung in W/Block bei 20 °C														
Exide Typ-bezeichnung	Sachnummer	3 min	5 min	10 min	15 min	20 min	30 min	45 min	1 h	2 h	3 h	5 h	8 h	10 h
S506/130	NAS5060130HWOMC	1365	1282	1078	890	764	609	466	385	231	168	113	75,0	63,0
S506/185	NAS5060185HWOMA	1636	1580	1404	1222	1081	869	667	535	313	222	148	103	91,0
S512/25	NAS5120025HWOMA	660	588	448	362	305	240	185	153	92,0	68,0	44,0	29,0	25,0
S512/38	NAS5120038HWOMC	927	818	627	515	436	340	263	216	133	100	67,0	44,0	37,0
S512/50	NAS5120050HWOMC	1338	1170	896	727	610	481	375	313	185	134	90,0	59,0	50,0
S512/60	NAS5120060HWOMC	1806	1593	1197	958	798	605	446	359	220	160	107	71,0	60,0
S512/92	NAS5120092HWOMA	1836	1643	1272	1090	965	778	606	505	313	230	152	105	90,0

1,85 V/Z – Entladung in W/Block bei 20 °C														
Exide Typ-bezeichnung	Sachnummer	3 min	5 min	10 min	15 min	20 min	30 min	45 min	1 h	2 h	3 h	5 h	8 h	10 h
S506/130	NAS5060130HWOMC	1806	1617	1281	1035	861	665	511	420	255	188	124	81,0	68,0
S506/185	NAS5060185HWOMA	2141	2010	1677	1414	1232	970	732	596	343	242	165	113	97,0
S512/25	NAS5120025HWOMA	859	732	529	419	348	267	205	167	100	73,0	48,0	31,0	26,0
S512/38	NAS5120038HWOMC	1220	1025	747	598	498	382	291	240	149	112	73,0	48,0	40,0
S512/50	NAS5120050HWOMC	1719	1456	1064	846	706	543	411	337	202	147	99,0	64,0	54,0
S512/60	NAS5120060HWOMC	2228	1909	1390	1097	904	672	492	399	246	180	116	77,0	64,0
S512/92	NAS5120092HWOMA	2258	1960	1505	1263	1100	859	666	556	343	250	167	115	97,0

1,80 V/Z – Entladung in W/Block bei 20 °C														
Exide Typ-bezeichnung	Sachnummer	3 min	5 min	10 min	15 min	20 min	30 min	45 min	1 h	2 h	3 h	5 h	8 h	10 h
S506/130	NAS5060130HWOMC	2100	1911	1463	1148	945	714	536	439	267	198	130	84,0	70,0
S506/185	NAS5060185HWOMA	2565	2353	1899	1566	1343	1040	777	626	363	257	173	117	101
S512/25	NAS5120025HWOMA	1013	845	597	459	378	286	216	176	104	78,0	50,0	32,0	27,0
S512/38	NAS5120038HWOMC	1440	1195	855	664	548	415	313	257	159	120	77,0	50,0	41,5
S512/50	NAS5120050HWOMC	2004	1697	1210	941	778	588	442	358	216	158	104	67,0	56,0
S512/60	NAS5120060HWOMC	2540	2128	1523	1197	978	718	525	426	259	190	124	80,0	66,5
S512/92	NAS5120092HWOMA	2605	2202	1717	1414	1202	929	710	588	359	260	176	120	101

1,75 V/Z – Entladung in W/Block bei 20 °C														
Exide Typ-bezeichnung	Sachnummer	3 min	5 min	10 min	15 min	20 min	30 min	45 min	1 h	2 h	3 h	5 h	8 h	10 h
S506/130	NAS5060130HWOMC	2352	2100	1554	1218	994	749	551	448	273	203	133	86,0	71,0
S506/185	NAS5060185HWOMA	2838	2570	2040	1656	1414	1087	810	652	373	264	178	120	102
S512/25	NAS5120025HWOMA	1112	915	635	486	400	297	221	178	106	80,0	51,0	33,0	28,0
S512/38	NAS5120038HWOMC	1585	1300	909	706	577	432	320	261	161	122	79,0	51,5	42,5
S512/50	NAS5120050HWOMC	2212	1837	1288	997	818	610	454	364	220	162	107	69,0	56,5
S512/60	NAS5120060HWOMC	2746	2288	1623	1264	1026	752	552	446	264	194	126	82,0	68,0
S512/92	NAS5120092HWOMA	2899	2485	1840	1475	1242	958	730	605	364	265	181	122	102

1,70 V/Z – Entladung in W/Block bei 20 °C														
Exide Typ-bezeichnung	Sachnummer	3 min	5 min	10 min	15 min	20 min	30 min	45 min	1 h	2 h	3 h	5 h	8 h	10 h
S506/130	NAS5060130HWOMC	2541	2230	1624	1260	1029	763	559	455	277	207	134	87,0	72,0
S506/185	NAS5060185HWOMA	3101	2778	2161	1727	1454	1101	818	659	378	268	182	123	103
S512/25	NAS5120025HWOMA	1188	972	664	505	411	305	224	180	107	81,0	52,0	34,0	28,0
S512/38	NAS5120038HWOMC	1697	1378	950	730	597	440	324	264	163	124	80,0	52,0	43,0
S512/50	NAS5120050HWOMC	2374	1954	1344	1030	846	627	460	370	223	165	108	70,0	57,0
S512/60	NAS5120060HWOMC	2920	2418	1689	1297	1052	765	565	456	268	197	128	83,0	69,0
S512/92	NAS5120092HWOMA	3272	2730	1940	1525	1263	969	740	613	369	269	183	123	103

1,65 V/Z – Entladung in W/Block bei 20 °C														
Exide Typ-bezeichnung	Sachnummer	3 min	5 min	10 min	15 min	20 min	30 min	45 min	1 h	2 h	3 h	5 h	8 h	10 h
S506/130	NAS5060130HW0MC	2639	2296	1666	1281	1050	770	564	460	279	209	135	88,0	72,0
S506/185	NAS5060185HW0MA	3343	2959	2215	1767	1474	1112	824	664	382	271	184	124	104
S512/25	NAS5120025HW0MA	1239	1007	680	513	419	311	226	181	108	81,0	52,0	34,0	28,0
S512/38	NAS5120038HW0MC	1755	1428	971	743	605	446	328	267	165	125	80,0	52,0	43,0
S512/50	NAS5120050HW0MC	2475	2022	1378	1053	857	632	463	373	225	167	108	70,0	57,0
S512/60	NAS5120060HW0MC	3092	2520	1729	1323	1071	778	572	461	271	199	129	84,0	69,0
S512/92	NAS5120092HW0MA	3616	2969	2040	1566	1283	980	750	621	372	271	184	124	104

1,60 V/Z – Entladung in W/Block bei 20 °C														
Exide Typ-bezeichnung	Sachnummer	3 min	5 min	10 min	15 min	20 min	30 min	45 min	1 h	2 h	3 h	5 h	8 h	10 h
S506/130	NAS5060130HW0MC	2674	2324	1694	1300	1057	777	567	462	280	210	135	88,0	72,0
S506/185	NAS5060185HW0MA	3495	3060	2262	1800	1485	1121	828	667	384	273	185	124	104
S512/25	NAS5120025HW0MA	1266	1026	691	520	424	313	227	181	108	81,0	52,0	34,0	28,0
S512/38	NAS5120038HW0MC	1793	1453	984	750	610	450	332	269	166	125	80,0	52,0	43,0
S512/50	NAS5120050HW0MC	2554	2061	1400	1060	868	638	465	375	226	168	108	70,0	57,0
S512/60	NAS5120060HW0MC	3212	2600	1756	1340	1084	791	579	466	273	200	129	84,0	69,0
S512/92	NAS5120092HW0MA	3808	3070	2091	1600	1303	990	758	626	374	273	185	124	104

Exide Technologies Industrial Energy – Batterie Systeme für die Welt.



Exide Technologies, mit Niederlassungen in 80 Ländern, ist einer der weltweit größten Hersteller und Recycler von Blei-Säure-Batterien. Exide bietet ein umfassendes und auf Kunden zugeschnittenes Programm für Lösungen zur Speicherung elektrischer Energie.

Mit mehr als 100 Jahren Erfahrung in der Entwicklung innovativer Technologien ist Exide geschätzter Partner der Erstausrüster und bedient den Ersatzteilmarkt für Anwendungen in der Industrie und im Verkehrswesen. Der Geschäftsbereich Industrial Energy bietet eine umfangreiche Palette an Speicherprodukten und Dienstleistungen. Hierzu gehören Anwendungen für

Telekommunikationssysteme, für den Schienenverkehr, den Bergbau, der Photovoltaik (Solarstrom), für unterbrechungsfreie Stromversorgung (USV), der Energieversorgung und -verteilung sowie für Gabelstapler und Elektrofahrzeuge.

Exide Technologies ist stolz auf seine Bestrebungen zum Umweltschutz. Das Unternehmen hat ein umfassendes Management-Programm (einen integrierten Ansatz für die Herstellung, den Vertrieb und das Recycling von Bleisäureakkumulatoren) ins Leben gerufen, um den gesamten Lebenszyklus seiner Produkte sicher und verantwortungsbewusst zu gestalten.